

SILICON RECTIFIER

VOLTAGE RANGE 50 to 1000 Volts CURRENT 1.5 Amperes

FEATURES

- * Low cost
- * Low leakage
- * Low forward voltage drop
- * High current capability

MECHANICAL DATA

- * Case: Molded plastic
- * Epoxy: Device has UL flammability classification 94V-O
- * Lead: MIL-STD-202E method 208C guaranteed
- * Mounting position: Any
- * Weight: 0.38 gram



DO-15

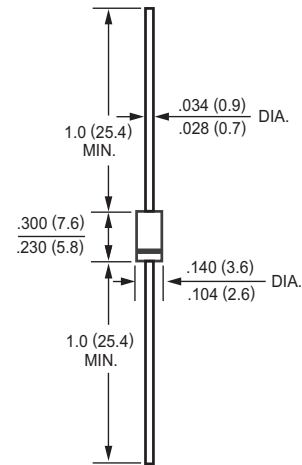

MAXIMUM RATINGS AND ELECTRICAL CHARACTERISTICS

Ratings at 25 °C ambient temperature unless otherwise specified.
Single phase, half wave, 60 Hz, resistive or inductive load.
For capacitive load, derate current by 20%.

MAXIMUM RATINGS (At TA = 25°C unless otherwise noted)

| RATINGS | SYMBOL | 1N5391 | 1N5392 | 1N5393 | 1N5394 | 1N5395 | 1N5396 | 1N5397 | 1N5398 | 1N5399 | UNITS |
|--|------------------|--------------|--------|--------|--------|--------|--------|--------|--------|--------|------------------|
| Maximum Recurrent Peak Reverse Voltage | VRRM | 50 | 100 | 200 | 300 | 400 | 500 | 600 | 800 | 1000 | Volts |
| Maximum RMS Voltage | VRMS | 35 | 70 | 140 | 210 | 280 | 350 | 420 | 560 | 700 | Volts |
| Maximum DC Blocking Voltage | VDC | 50 | 100 | 200 | 300 | 400 | 500 | 600 | 800 | 1000 | Volts |
| Maximum Average Forward Rectified Current .375" (9.5mm) lead length at TL = 70°C | Io | 1.5 | | | | | | | | | Amps |
| Peak Forward Surge Current 8.3 ms single half sine-wave superimposed on rated load (JEDEC method) | IFSM | 50 | | | | | | | | | Amps |
| Typical Current Squared Time | I ² T | 10.37 | | | | | | | | | A ² S |
| Typical Junction Capacitance (Note) | CJ | 20 | | | | | | | | | pF |
| Typical Thermal Resistance | RθJA | 50 | | | | | | | | | °C/W |
| Operating and Storage Temperature Range | TJ, TSTG | -65 to + 175 | | | | | | | | | °C |

ELECTRICAL CHARACTERISTICS (At TA = 25°C unless otherwise noted)

| CHARACTERISTICS | SYMBOL | 1N5391 | 1N5392 | 1N5393 | 1N5394 | 1N5395 | 1N5396 | 1N5397 | 1N5398 | 1N5399 | UNITS |
|---|-------------|--------|--------|--------|--------|--------|--------|--------|--------|--------|-------|
| Maximum Instantaneous Forward Voltage at 1.5A DC | VF | 1.0 | | | | | | | | | Volts |
| Maximum DC Reverse Current at Rated DC Blocking Voltage | @TA = 25°C | 1.0 | | | | | | | | | uAmps |
| | @TA = 100°C | 50 | | | | | | | | | |
| Maximum Full Load Reverse Current Average, Full Cycle .375" (9.5mm) lead length at TL = 75°C | IR | 30 | | | | | | | | | uAmps |

NOTES : Measured at 1 MHz and applied reverse voltage of 4.0 volts

RATING AND CHARACTERISTIC CURVES (1N5391 THRU 1N5399)

FIG. 1 - TYPICAL FORWARD CURRENT DERATING CURVE

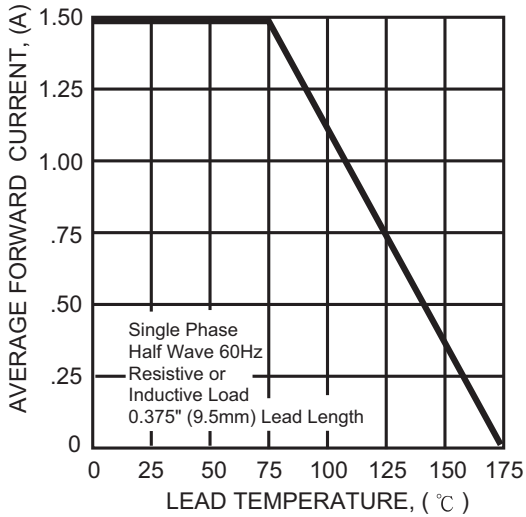

FIG. 2 - TYPICAL INSTANTANEOUS FORWARD CHARACTERISTICS

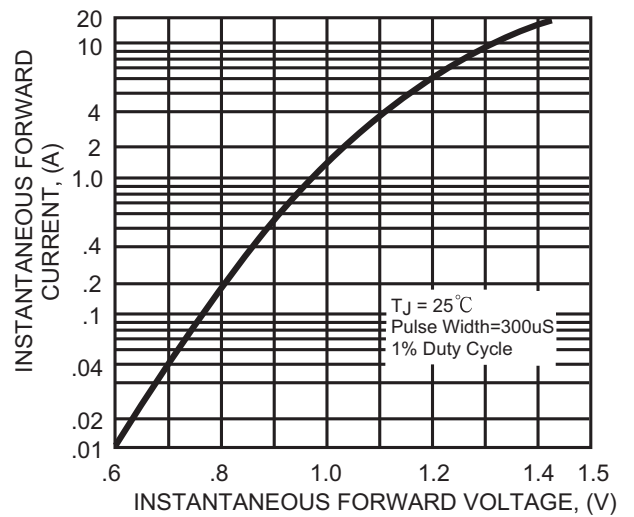

FIG. 3 - MAXIMUM NON-REPETITIVE FORWARD SURGE CURRENT

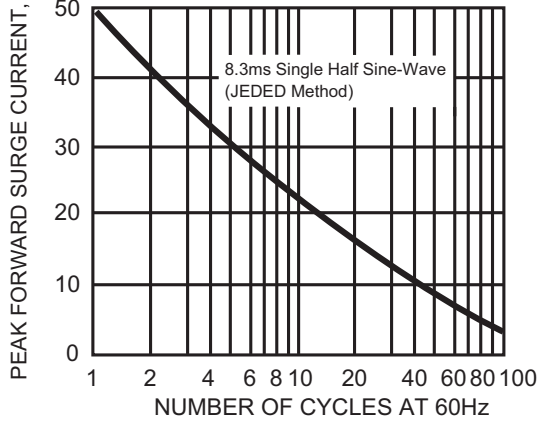

FIG. 4 - TYPICAL JUNCTION CAPACITANCE

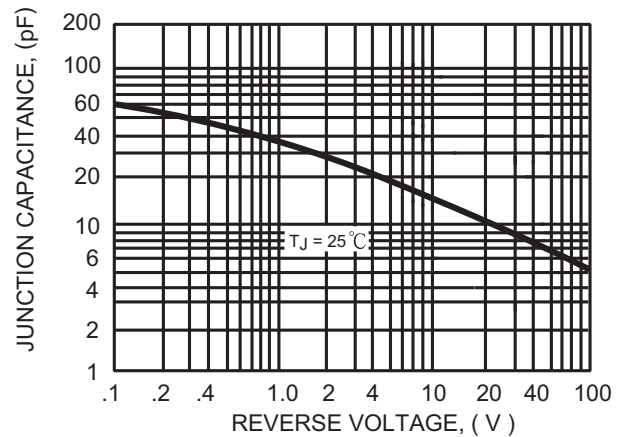
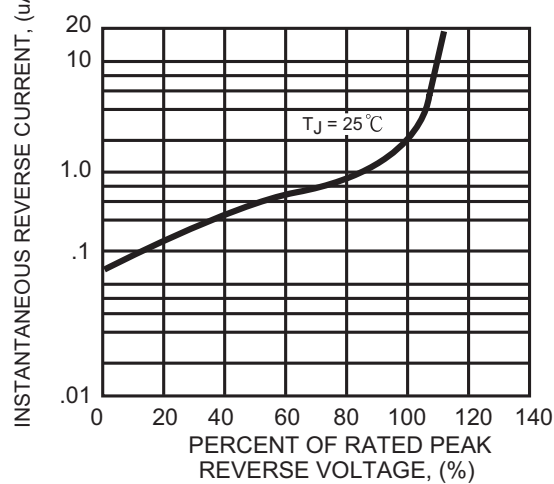

FIG. 4 - TYPICAL REVERSE CHARACTERISTICS





Attachment information about 1N539X

1. Internal Circuit



2. Marking on the body

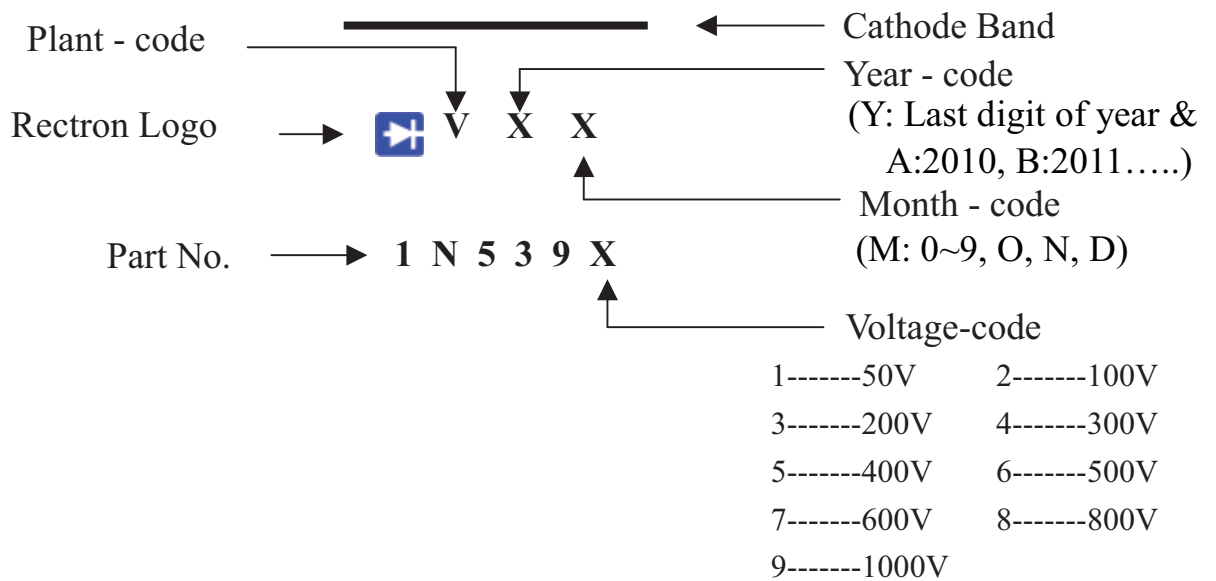

PACKAGING OF DIODE AND BRIDGE RECTIFIERS

BULK PACK

| PACKAGE | PACKING CODE | EA PER BOX | INNER BOX SIZE (mm) | CARTON SIZE (mm) | EA PER CARTON | GROSS WEIGHT(Kg) |
|---------|--------------|------------|---------------------|------------------|---------------|------------------|
| DO-15 | -B | 500 | 194*84*21 | 415*220*255 | 25,000 | 12.74 |

REEL PACK

| PACKAGE | PACKING CODE | EA PER REEL | EA PER INNER BOX | COMPONENT SPACE (mm) | TAPE SPACE (mm) | REEL DIA (mm) | CARTON SIZE (mm) | EA PER CARTON | GROSS WEIGHT(Kg) |
|---------|--------------|-------------|------------------|----------------------|-----------------|---------------|------------------|---------------|------------------|
| DO-15 | -T | 4,000 | 4,000 | 5.0 | 52 | 330 | 355*350*335 | 16,000 | 10.05 |

AMMO PACK

| PACKAGE | PACKING CODE | REEL (EA) | COMPONENT SPACE(mm) | TAPE SPACE (mm) | BOX SIZE (mm) | CARTON SIZE(mm) | CARTON (EA) | GROSS WEIGHT (Kg) |
|---------|--------------|-------------|---------------------|-----------------|---------------|-----------------|---------------|-------------------|
| DO-15 | -F | 1,500 | 5.0 | 52 | 255*73*100 | 400*268*225 | 15,000 | 8.8 |

DISCLAIMER NOTICE

Rectron Inc reserves the right to make changes without notice to any product specification herein, to make corrections, modifications, enhancements or other changes. Rectron Inc or anyone on its behalf assumes no responsibility or liability for any errors or inaccuracies. Data sheet specifications and its information contained are intended to provide a product description only. "Typical" parameters which may be included on RECTRON data sheets and/ or specifications can and do vary in different applications and actual performance may vary over time. Rectron Inc does not assume any liability arising out of the application or use of any product or circuit.

Rectron products are not designed, intended or authorized for use in medical, life-saving implant or other applications intended for life-sustaining or other related applications where a failure or malfunction of component or circuitry may directly or indirectly cause injury or threaten a life without expressed written approval of Rectron Inc. Customers using or selling Rectron components for use in such applications do so at their own risk and shall agree to fully indemnify Rectron Inc and its subsidiaries harmless against all claims, damages and expenditures.