

# REEL TAPING SPECIFICATIONS FOR SURFACE MOUNT DEVICES-SOD-323

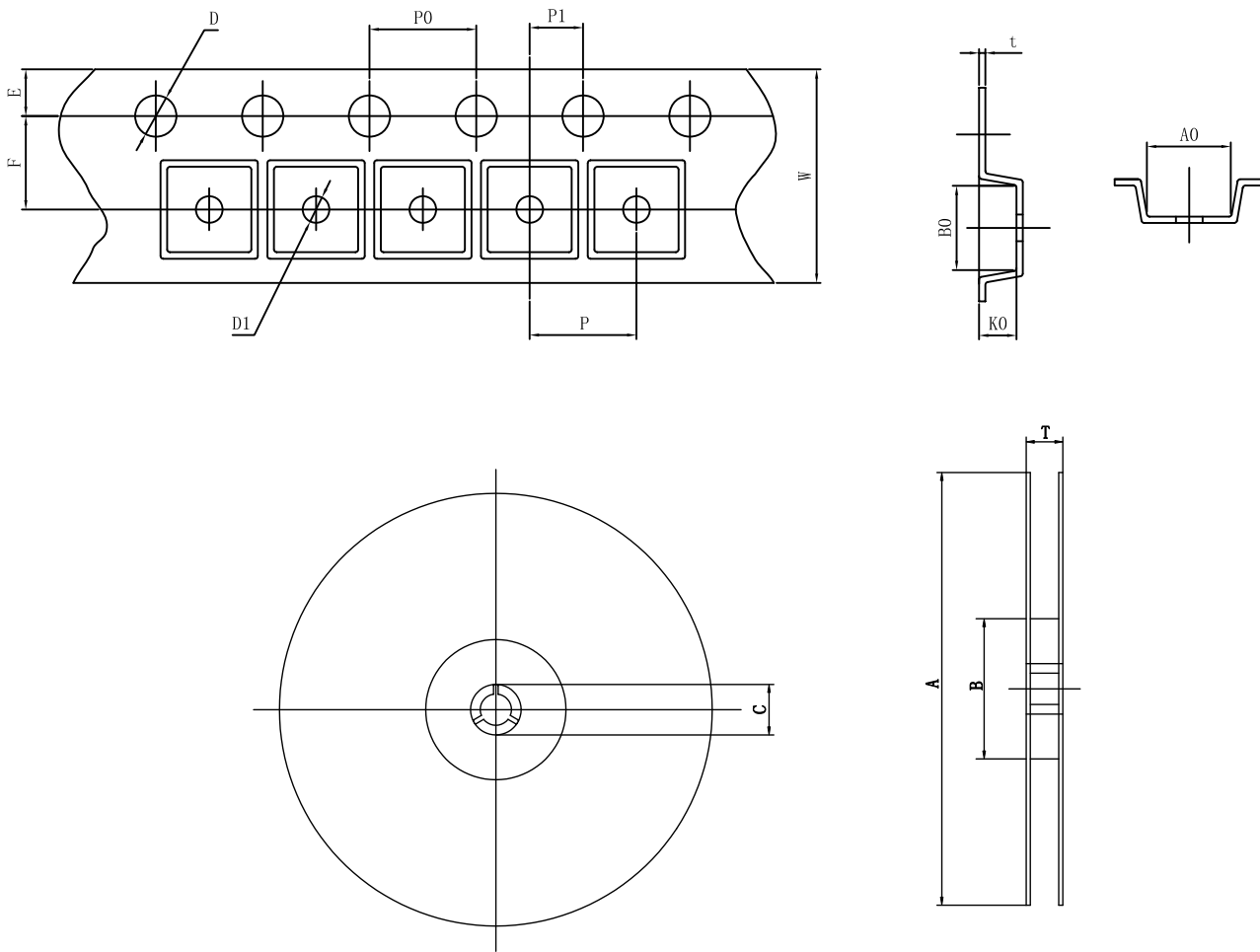

Fig.: Configuration of SOD-323 TAPING

ITEM	SYMBOL	SPECIFICATIONS (mm)	SPECIFICATIONS (inch)
Carrier width	A0	1.62 Max.	0.064 Max.
Carrier length	B0	3.0 Max.	0.118 Max.
Carrier depth	K0	1.45 Max.	0.057 Max.
Sprocket hole	D	1.5±0.1	0.059±0.004
Reel outside diameter	A	178±1.0	7.009±0.039
Reel inner diameter	B	54 Min.	2.126 Min.
Feed hole diameter	C	13.0±0.20	0.512±0.008
Strocket hole position	E	1.75±0.10	0.069±0.004
Punch hole position	F	3.5±0.05	0.138±0.002
Punch hole pitch	P	4.0±0.10	0.158±0.004
Sprocket hole pitch	P0	4.0±0.10	0.158±0.004
Embossment center	P1	2.0±0.05	0.079±0.002
Overall tape thickness	t	0.267 Max.	0.011 Max.
Tape width	W	8.0+0.3/-0.1	0.315+0.012/-0.004
Reel width	T	12.5 Max.	0.492 Max.
Punch hole diameter	D1	1.25 Max.	0.049 Max.

Note : Devices are packed in accordance with EIA standard RS-481-A and specification given above. Available only for SOD-323 devices.